

Single Arm Operator (Face - Mount)

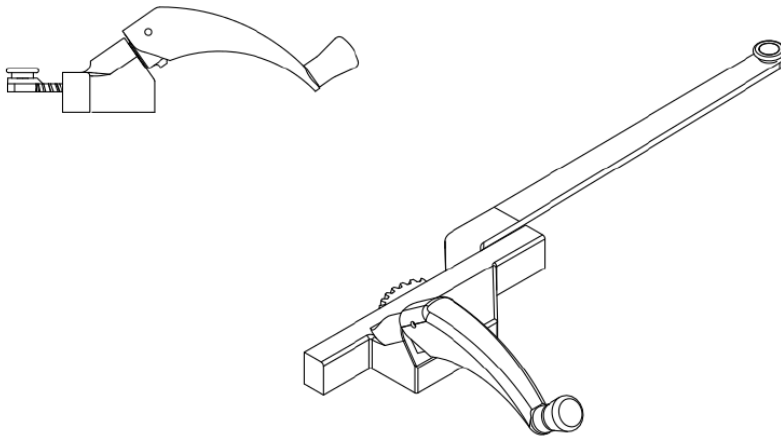

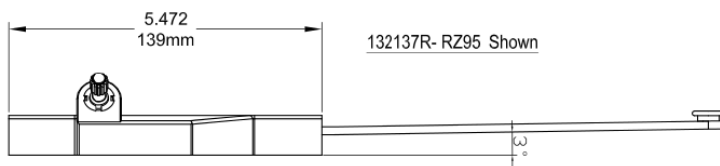
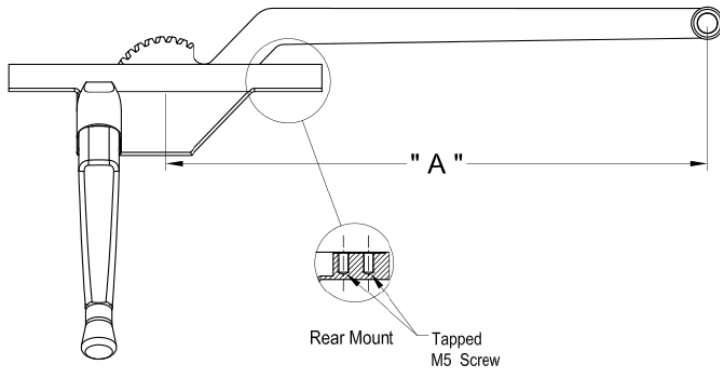
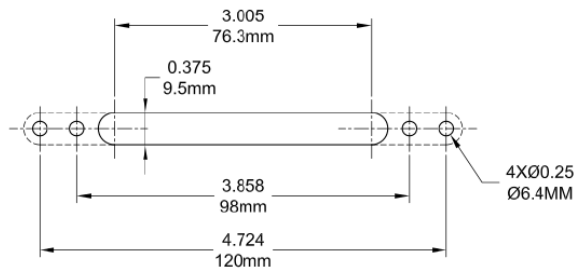

Profile Cut Out

Product Name	Part Number	"A" Arm Length
Face Mount Single Arm Operator 7.5", Rear Mount, RH	132137R - RZ75X	7.5 "
Face Mount Single Arm Operator 7.5", Rear Mount, LH	132137R - LZ75X	7.5 "
Face Mount Single Arm Operator 9.5", Rear Mount, RH	132137R - RZ95X	9.5 "
Face Mount Single Arm Operator 9.5", Rear Mount, LH	132137R - LZ95X	9.5 "
Face Mount Single Arm Operator 13.5", Rear Mount, RH	132137R - RZ135X	13.5 "
Face Mount Single Arm Operator 13.5", Rear Mount, LH	132137R - LZ135X	13.5 "

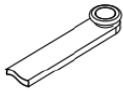

<1> SST Roller

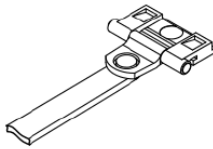

<2> Plastic Slider

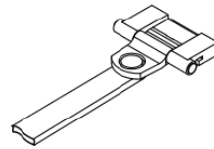

<3> Small Brass Slider

- <1> This is default, in this case, no letter attached
- <2> "X" = A Stands for Plastic Slider
- <3> "X" = B Stands for Small Brass Slider

Gasket 20137

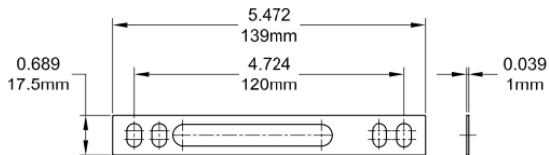

Backing Plate 190137

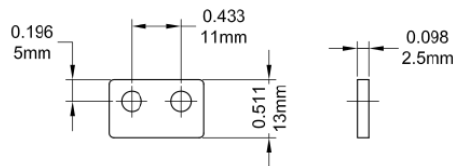

NOTE: (QTY2) Backing Plates Required Per Operator

Track

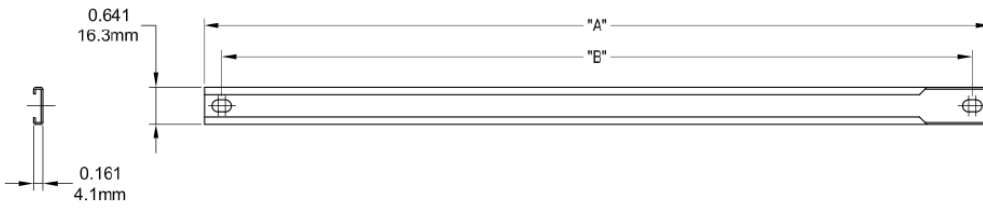

Single Arm Operator Track 2 holes			
Part Number	" A "	" B "	Material
70054	9.5"	8.87"	SST
70055	13.75"	13.12"	SST
70056	17.795"	17.165"	SST